

DESCRIPTION

Element from the Mini Park series. In combination with other modules, it creates various types of obstacles in the form of ladders, climbing, moving bridges.

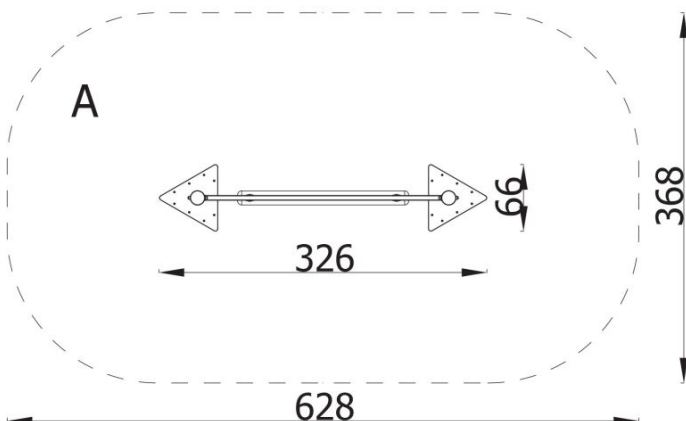
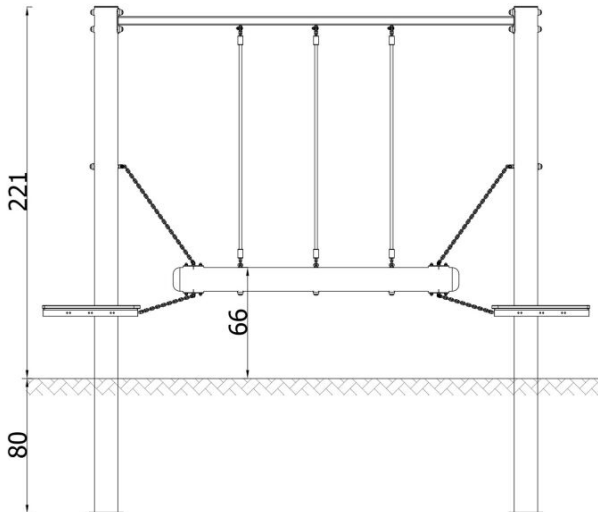
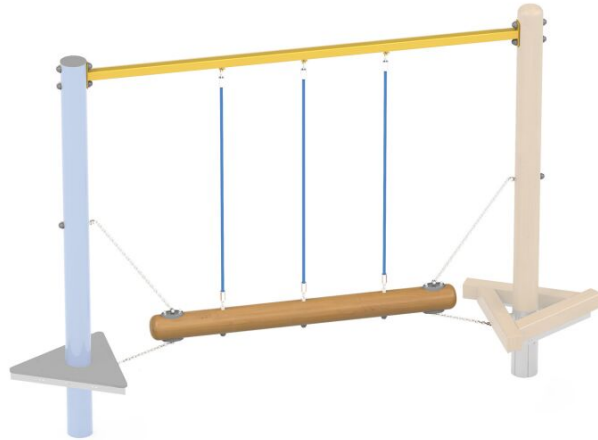

INFORMATION

| | |
|--------------------------|-------------------|
| Number of users | 4 |
| Age range | 3 - 14 |
| Device dimensions [m] | 0.78 x 2.2 x 3.38 |
| Compliance with the norm | EN 1176 |
| Spare parts | |

SAFETY SURFACE

| Zone | Max height of fall [m] | Area [m ²] | Perimeter of safety zone [m] |
|------|------------------------|------------------------|------------------------------|
| A | 0.58 | 22.39 | 17.82 |
| B | | | |
| C | | | |